

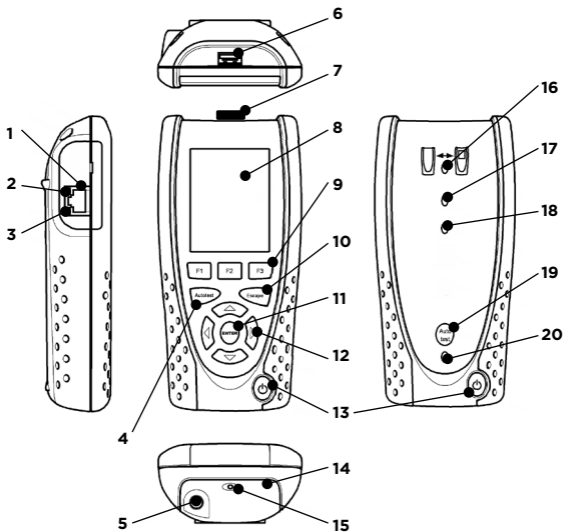

TREND NETWORKS

SignalTEK CT





- | | | | |
|----|-------------|----|----------------|
| 1 | 线缆插座 | 11 | 确认键 |
| 2 | 以太网 LED 指示灯 | 12 | 光标键 |
| 3 | 活动 LED 指示灯 | 13 | 电源键 |
| 4 | 自动测试键 | 14 | 电池模块 |
| 5 | 直流电源输入口 | 15 | 充电 LED 指示灯 |
| 6 | USB 端口 | 16 | 链路 LED 指示灯 |
| 7 | Wi-Fi 适配器 | 17 | 合格/不合格 LED 指示灯 |
| 8 | 触摸显示屏 | 18 | 已保存 LED 指示灯 |
| 9 | 功能键 | 19 | 远端机自动测试键 |
| 10 | 退出键 | 20 | 电池状态 LED 指示灯 |

充电 LED 指示灯 (15)	状态
绿色	充电中
关闭	充电完成
闪烁	未充电

合格/不合格 LED 指示灯 (17)	状态
绿色	已通过测试
红色	未通过测试

电池状态 LED 指示灯 (20)	状态
绿色 (开启电源)	电量充足, 足够使用
红色 (开启电源)	电量不足, 仍可运行
关闭	关闭电源

4 种操作方法

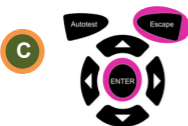

退出 - 返回至上一屏幕

确认 - 接受选择



任务设置

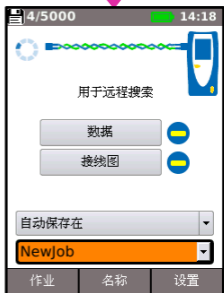
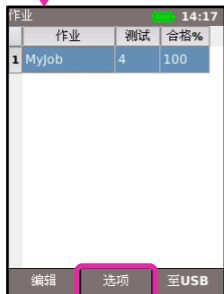

测试设置

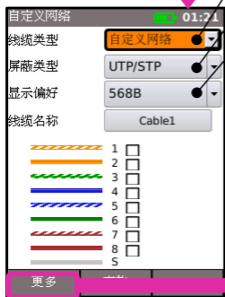
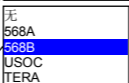
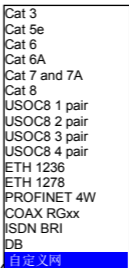

线缆测试



查看测试结果

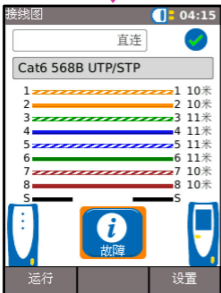
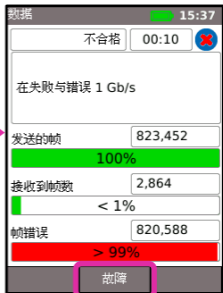
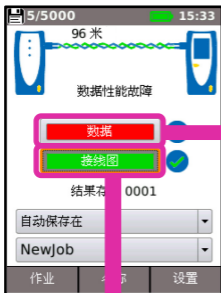

测试报告

已保存 5 项测试 / 存储量达 5000 项测试



显示已连接 Wi-Fi

选择保存结果模式

选择当前任务文件夹

关闭“自动保存”时，手动保存结果

查看结果



选择任务文



选择结果

或将报告保存至 U 盘

至USB

或使用智能手机通过 TRENDA AnyWARE APP 应用程序

(Android/iOS) 下载报告

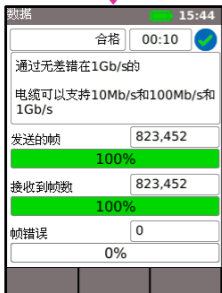

菜单结构图

